



## DVD RECEIVER SYSTEM Operating Instruction Manual

# DVD5045 DVD RECEIVER SYSTEM



Manufactured under license from Dolby Laboratories. "Dolby",  
"Pro Logic" and the double-D symbol are trademarks of Dolby  
Laboratories. Confidential Unpublished Works. ©1992-1997  
Dolby Laboratories, Inc. all rights reserved.



MAN-DVD5045

- Built-in Dolby Digital decoding for maximum home entertainment enjoyment •
- Unique laser-head over-current protection system doubles service life •
- Special DVD deck features fully dust proof and anti shock design as well as augmented error correction and better stability •
- Fully functional DVD operating system offers many favorite functions and user-friendly operation •
- Integrated DVD and built-in 6-channel Hi-Fi amplifier •

## PRECAUTIONS

A lightning bolt with an arrowhead symbol within an equilateral triangle is intended to alert the user to the presence of uninsulated "dangerous voltage" within the product's enclosure that may be of sufficient magnitude to constitute a risk of electric shock to persons.



The exclamation point within an equilateral triangle is intended to alert the user to the presence of important operating and maintenance (servicing) instructions in the literature accompanying the appliance.



**WARNING:** TO AVOID THE DANGER OF FIRE OR ELECTRIC SHOCK, DO NOT EXPOSE THIS APPLIANCE TO RAIN OR MOISTURE. NEVER OPEN THE CABINET, AS DANGEROUS HIGH VOLTAGES ARE CONTAINED INSIDE. ONLY A QUALIFIED SERVICE TECHNICIAN SHOULD ATTEMPT TO OPEN THE CABINET.

**CAUTION:** TO PREVENT ELECTRIC SHOCK, MATCH WIDE BLADE OF PLUG TO WIDE SLOT, AND FULLY INSERT INTO ELECTRICAL SOCKET.

**CAUTION:** This DVD receiver unit employs a laser system. To prevent direct exposure to the laser beam, do not open the enclosure. Visible laser radiation is present when enclosure is open. DO NOT STARE INTO BEAM. Additionally, the use of controls or adjustments or performance of procedures other than those specified herein may result in hazardous radiation exposure.

To ensure proper use of this product, please read this owner's manual carefully and retain for future reference. Should the unit require maintenance, contact an authorized service location, or contact CURTIS Technology.

**FCC NOTICE:** This equipment has been tested and found to comply with the limits for a Class B digital device, pursuant to section 15 of the FCC rules. These limits are designed to provide reasonable protection against harmful interference in a residential installation.

This equipment generates, uses, and can radiate radio frequency energy and, if not installed and used in accordance with the instructions, may cause harmful interference to radio communication. However, this is no guarantee that interference will not occur in a particular installation. If this equipment does cause harmful interference to radio or television reception, which can be determined by turning the equipment off and on, the user is encouraged to try to correct the interference by one of the following measures:

- Reorient or relocate the receiving antenna
- Increase the separation between the equipment and receiver
- Connect the equipment into an outlet on a circuit different from that to which the receiver is connected
- Consult the dealer or an experienced radio/TV technician for help

**FCC Caution:** Any changes or modifications not expressly approved by CURTIS Technology could void the user's authority to operate this equipment.

### INDUSTRY CANADA REQUIREMENT

This Class B digital apparatus meets all requirements of the Canadian Interference-Causing Equipment Regulations.

THE REGION CODE FOR THIS UNIT IS 1.



**IMPORTANT:** DVDs are divided into separate regions. The United States and Canada are designated as region 1 DVD. This DVD player only plays region 1 DVDs. Since it is common for DVD movies to be released at different times in different regions of the world, all players have region codes, while discs may have an optional region code. If you load a disc of a different region code in this unit, you will see the region code notice on the screen. The disc will not play, and should be unloaded.

### PROTECT YOURSELF!

Record the model and serial numbers for this unit while it is easy to see them. These numbers are located on the back of the unit's cabinet. Retain this information for future reference.

Model No. DVD5045

Serial No. \_\_\_\_\_  
*Retain this information for future reference.*



**CAUTION**  
RISK OF ELECTRIC SHOCK DO NOT OPEN

**CAUTION:** TO REDUCE THE RISK OF ELECTRIC SHOCK, DO NOT REMOVE COVER (OR BACK). THERE IS NO USER SERVICEABLE PART INSIDE. REFER SERVICING TO QUALIFIED SERVICE PERSONNEL.

## IMPORTANT--SAFETY INFORMATION

**CAUTION:** Is it important that you read and follow all of the instructions in this booklet and any marked on the unit itself. Retain this booklet for future reference.

**Accessories---**Never place this product on an unstable platform, stand, cart, wall mount, shelf, or table. The product may fall, causing serious personal injury to persons and pets, as well as seriously damaging the product. Use only with a stable platform, stand, cart, wall mount, shelf, or table that has been recommended by CURTIS Technology or sold with the product. Any mounting of the product should follow the manufacturer's instructions, and use a mounting accessory recommended by the manufacturer. This unit while positioned on some type of cart must be moved with care. Quick stops, excessive force, and uneven surfaces may cause the product and cart combination to overturn.

**Attachments---**Use only attachments recommended by CURTIS Technology, as they may cause hazards.

**Cleaning---**Always unplug this unit from the wall electrical outlet before cleaning. Do not use liquid or aerosol cleaners; use a damp cloth for cleaning.

**Grounding or Polarization** - This product is equipped with either a polarized AC plug (a plug having one blade wider than the other) or with a three-wire grounding-type plug. These plugs fit into the power outlet only one way. This is a safety feature. If you are unable to insert the plug fully into the outlet, try reversing the plug. If the plug should still fail to fit, contact an electrician. Do not defeat the safety purpose of the polarized plug in any way or manner.

**Lightning---**For added product protection during a lightning storm or when it is left unattended and unused for long periods of time, unplug it from the wall outlet and/or disconnect the antenna or cable system. This will prevent damage to the product due to lightning and power-line surges.

**Object and Liquid Entry---**Never push objects of any kind into this product through openings as they may touch dangerous voltage points or short-out parts that could result in a fire or electric shock. Never spill liquid of any kind on or into the product.

**Outdoor Antenna Grounding---**If an outside antenna or cable system is connected to the product, be sure the antenna or cable system is grounded so as to provide protection against voltage surges and built-up static charges. Article 810 of the National Electrical Code, ANSI/NFPA 70, provides information with regard to proper grounding of the mast and supporting structure, grounding of the lead-in wire to an antenna discharge unit, size or grounding conductors, location of antenna-discharge unit, connection to grounding electrodes, and requirements for the grounding electrode.

**Overloading---**Do not overload wall outlets, extension cords, or integral convenience receptacles, as this may result in a fire or electric shock.

**Power-Cord Protection-**Power-supply cords should be routed so that they are not likely to be walked on or pinched by items placed upon or against them, paying particular attention to cords at plugs, convenience receptacles, and the point where they exit from the product.

**Power Lines---**An outside antenna system should not be located in the vicinity of overhead power lines or other electric light or power circuits, or where it can fall into such power lines or circuits. When installing an outside antenna system, extreme care should be taken to keep from touching such power lines or circuits as contact with them might be fatal.

**Power Sources---**This product should be operated only from the type of power source indicated on the marking label. If you are not sure of the type of power supply to your home, consult your product dealer or local power company. For products intended to operate from battery power or other sources, refer to the operating instructions. This DVD player operates on 120VAC/60Hz. Do not turn off unit immediately after turning on; wait at least 10 seconds.

**Replacement Parts---**If replacement parts are required, be sure the service technician has used replacement parts specified by CURTIS Technology or have the same characteristics as the original part. Unauthorized substitutions may result in fire, electric shock, or other hazards.

**Safety Check---**Upon completion of any service or repairs to this product, ask the service technician to perform safety checks to determine that the product is in proper operating condition.

**Servicing---**Do not attempt to service this product yourself as opening or removing covers may expose you to dangerous voltage or other hazards. Refer all servicing to qualified service personnel.

**TV System---**This unit is compatible with television sets featuring either the NTSC or PAL color system.

**Ventilation---**Slots and openings in the cabinet are provided for ventilation and to ensure reliable operation and protection from overheating. These openings should never be blocked by placing the product on a bed, sofa, rug, or other similar surface. This product should not be placed in a built-in installation such as a bookcase or rack unless proper ventilation is provided. Never place this product near a heat source, such as heat registers, stoves, radiators, or any other product that produces heat.

**Water and Moisture---**Do not use this product near sources of water and moisture, such as bath tub, wash bowl, kitchen sink, or wash machine; in a wet, damp basement; or near a swimming pool or similar locations. If moisture condensation occurs, remove any disc, connect the unit's power cord to a wall outlet, turn the unit on, and leave it on for two to three hours. By then, the unit will have warmed up and evaporated any moisture.

## DVD DVA-150A TECHNICAL SPECIFICATIONS

### DVD Player

TV System	NTSC/PAL
Compatible Discs	DVD, CD, MP3, CD-R, CD-RW
Resolution Ratio	Greater Than 500 lines
Video S/N Ratio	65dB
Frequency Response	fs (96KHz/24bit) 4Hz - 44KHz: +/-2dB
Audio S/N Ratio	95dB
Degree of Distortion	<0.01%
D/A Converter	192KHz/24bit
Video Out	1Vp-p
S-Video Out	Y: 1Vp-p(75Ω) C: 0.3Vp-p(75Ω)
Audio Out	2.0V ± 0.2V 5.1 Channel,
Digital Audio Output Connections	Optical Coaxial CVBS S-Video, YUV Output

### FM Tuner

Tuning Range	87.5-108MHz
S/N Ratio	>46dB
Monophonic	>46dB
Stereo	>50dB (DIN)

Selectance	50dB
THD	
Monophonic	2%
Stereo	3%
Frequency Response	30Hz-10kHz +/- 1dB
Stereo Resolution	35dB (1kHz) 30dB (100Hz-10kHz)

### AM Tuner

Tuning Range	522-1620kHz
S/N Ratio	35dB
THD	3%

### Amplifier

Distortion Limited Output Power:	
Main Speakers	20W+20W (4Ω)
Surround Speakers	20W+20W (4Ω)
Center Speaker	20W (4Ω)
Subwoofer	40W (8Ω)

Frequency Response:	
Main Speakers	200Hz-20kHz +/- 3dB
Surround Speakers	200Hz-20kHz +/- 3dB
Center Speaker	200Hz-20kHz +/- 3dB
Subwoofer	20Hz-200Hz +/- 3dB

S/N Ratio	> 76dB
Input Sensitivity	350mv, 47k
Channel Resolution	> 30dB (Normal)

### Remote Control

Transmitter	Infrared Ray
Signal Range	Approximately 15'
Power Source	2 "AAA" Batteries

### General

Power Supply	AC 120/60Hz
Consumed Power	150W

Because its products are subject to continuous improvement, CURTIS Technology reserves the right to modify product design and/or specifications without notice and without incurring any obligations.

This product incorporates copyright protection technology that is protected by method claims of certain U.S. Patents and other intellectual property rights owned by Macrovision Corporation and other right owners. Use of this copyright protection technology must be authorized by Macrovision Corporation, and is intended for home and other limited viewing uses only unless otherwise authorized by Macrovision Corporation. Reverse engineering or disassembly is prohibited.

JPEG adopting the most efficient compression is widely used as picture storage type flattened and stored format.

Even if pictures are compressed 15-20 times, they still have good effect. Supported by most picture processing software, fit for picture storage, it has small data and easy use. This machine can read JPEG-format-made picture CD disc.

Press relevant number key to select picture display.

1. Put in disc correctly, the machine begins to search disc information.
2. Press number key to select picture.

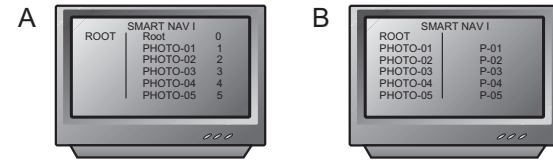

3. It's efficient only in present picture when press number key.

### Select to play by menu

1. Put in disc, machine searches disc information and main menu displays on screen. Press number key from 1 to select picture. Press play key to make sure.
2. Press direction key to select picture then press play key.
3. In condition of stop, press direction key to select other pictures.
4. In condition of stop, select the first line file item on the right. Then press play key, to return to upper menu.

Other functions:

1. When play JPEG, this machine has functions of pause, Play repeat and browse.
2. When play JPEG, press Resume key to different selections of picture display format.
3. Press + and - key to select pictures.
4. You can zoom the picture to press zoom key. Pressing it again, will return to normal play status.
5. When zoom on, press fast forward or fast return key to get picture zoom in or out function.
6. When zoom off, press direction key to get picture turnover.

This handy trouble-shooting guide is provided to save you time in case you experience any inconvenience with this DVD player. If the problem is not listed or if the provided solution does not correct the problem, please call our customer support department.

### Problem Possible Solution

#### No power

1. Check to ensure that the power plug is securely in the wall outlet.

#### No sound

1. Check the connection between the DVD player and the TV set, amplifier, or any other unit it is connected to.
2. Check to ensure the TV and amplifier are in the correct mode (video 1).

#### No picture

1. Check the connection between the DVD player and the TV set or any other unit it is connected to.
2. Check to make sure TV is turned on.

#### Disc does not play

1. Check to make sure the disc is loaded correctly label side facing up on disc tray.
2. Check that disc is clean from dirt, dust, fingerprints, and smudges.
3. Check to ensure disc is within the guides on the tray.
4. Check if parental lock function is on.
5. Make sure disc is for use in region 1.

#### Remote does not work

1. Check batteries; possibly replace.
2. Check to ensure there isn't any obstacles between the remote sensor on the unit's front panel and the remote control.
3. Be sure the remote is aimed at the remote sensor.

#### Divided picture

1. Check that disc is clean and has no scratches.
2. The unit is controlled by a micro computer, which may need to be reset. Turn off the unit's power, wait several seconds, then turn back on.

#### No color picture

1. Check to see if the S connector is damaged (bent pin).

#### MP3 discs don't play

1. Use another software edition to re-burn disc, as the edition used may not be compatible with the player.
2. Use new editions of software such as Audio station 4, "Easy CD Creator", Toast Titanium, etc.
3. Make sure MP3 file is not encoded with a variable bit rate, such as provided by Real Networks.

Precaution.....	1
Safety Information .....	2
Table of Contents .....	3
About Your DVD Player .....	4
Best Location.....	4
To Obtain a Clear Picture.....	4
Playable Discs.....	4
Digital Audio Output .....	4
Analog audio output.....	4
Laser-Head Over-Current Protection System.....	4
Use of Discs .....	5
Handling.....	5
Cleaning.....	5
Storing.....	5
Front and back Panels .....	6
Front Panel functions.....	6
Back Panel functions.....	6
Remote Controller .....	7
Operating the remote control.....	8
Connecting Devices.....	9
Speakers.....	10
Arrangement of speakers.....	10
Connecting speakers.....	11
Connecting antenna.....	12
Connecting power supply.....	13
Playing the radio.....	14
Basic DVD operation.....	15
Functions.....	16
System setup.....	19
Preference setup.....	24
Mp3 function.....	25
JPEG files.....	26
Trouble shooting.....	26
DVD5045 technical specifications.....	27

## ABOUT YOUR DVD PLAYER

The following will help you get the most enjoyment from your DVD receiver system.

### BEST LOCATION

The unit should be placed on a firm, flat surface, away from VCRs, stereos, radios, or large speakers, as the magnetic flux from these devices may cause distortion in the sound and a poor picture. If placed in a cabinet, be sure there is at least "1" of free space completely around the unit for proper ventilation.

### TO OBTAIN A CLEAR PICTURE

A DVD receiver is a precision device. If the optical pick-up lens and disc drive parts become dirty or worn down, picture quality will become poor. To obtain a clear picture, regular inspection and maintenance are recommended every 1,000 hours of use, depending on the operating environment. Contact dealer for details.

### PLAYABLE DISCS

This DVD receiver system will play the following types of discs: DVD, MP3, CD, CD-R, and CD-RW with super-error correction ability. It is also capable of displaying picture CDs and digital photo albums. It supports eight languages, up to 32 subtitles, and multi-angle viewing. It features easy setup and operation with on-screen menus. It has full function CPU upgrade capability.

### DIGITAL AUDIO OUTPUT

The unit's coaxial output capability enables you to connect an external six-channel AV amplifier and processor with built-in Dolby Digital codec and MPEG or DTS modulating capacity with just one cord. This enables you to conveniently enjoy different DVD, CD, and MP3 discs.

### ANALOG AUDIO OUTPUT

Speaker system plug-and-play convenience through the built-in six-channel power amplifier eliminates the use of an external power amplifier.

### LASER-HEAD OVER-CURRENT PROTECTION SYSTEM

To extend the service life of the laser head, the unit includes a unique laser-head over-current protection system, ensuring a constant laser current.

## PREFERENCE SETUP

### AGE CONTROL

Follow the operating instructions stated in "DVD MENU SETUP" in combination with the desired option in the following figure.

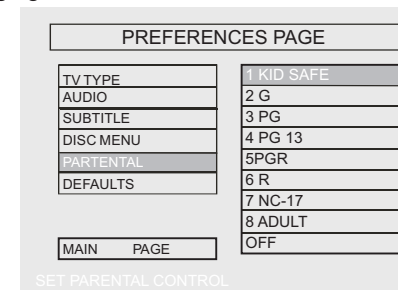

For a film to be restricted for children, the film class may be set according to label marking on the disc.

### DEFAULTS

This option will resume the original settings of this machine.

Follow the operating instructions stated in "DVD MENU SETUP" in combination with the desired option in the following figure.

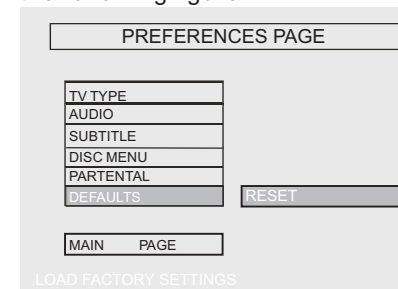

### PIN SETUP

Follow the operation instructions stated in "DVD menu setup" in combination with desired option in the following figure.

### PIN SETUP

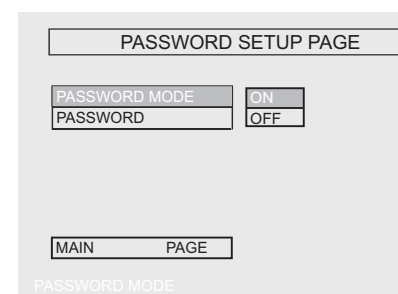

### PASSWORD

The default is "0000" The user may change it using this option

Follow the operating instructions stated in "DVD MENU SETUP" in combination with the desired option in the following figure.

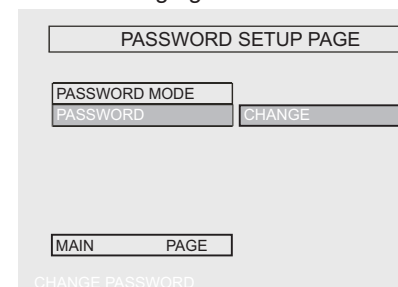

## MP3 FUNCTION

### OPERATION OF MP3 FUNCTION

MP3 is an audio compression mode using Level 3 of the international standard MPEG, whereby sound signal is compressed in a rate of 12:1. A Mp3 disc can record music for play of over 600 minutes or record over 170 songs, rivaling CDs in sound quality.

### To play a MP3 disc

#### Music Menu of MP3 play

When playing a MP3 disc, 3 music menus can be selected by pressing PROGRAM key: NORMAL LIST, PROGRAM LIST, FILE LIST.

- 1. NORMAL LIST**  
Display menu first then press UP DOWN, LEFT RIGHT arrow and ENTER key to select subdirectory and music.
- 2. PROGRAM LIST**  
Press up DOWN arrow key to select the music to be programmed on left column; press ENTER key to list the music in right column, Repeating above operations to finish programing selection. Now press RIGHT arrow key to select programing music and ENTER key to enter program play.
- 3. FILE LIST**  
It may select the music to be played by pressing UP DOWN, LEFT RIGHT arrow key combining with ENTER key, or using number keys and ENTER key to select directly. If the number input is out of the music number, " invalid input" will display on screen.

### Play Mode

There is five kind of play mode: FOLDER, SINGLE, REPEAT ONE, REPEAT FOLDER, SHUFFLE.

1. When in stop, press left, right arrow key to enter play mode and press up, down arrow key to select 5 different kinds.
2. FOLDER : play whole music menu orderly.
3. SINGLE: play a single music.
4. REPEAT ONE: play a single music repeatedly.
5. REPEAT FOLDER: play music menu repeatedly.
6. SHUFFLE: random play.



During stop mode, press the SETUP button to access the INITIAL SETUP menu, which includes items of dubbing language, subtitle, disc menu language, age control, default values smart NAV main menu .

Preset values are essential to a DVD player. The user may change these items as desired.

### TV TYPE

Follow the operation instructions stated in "DVD menu setup" in combination with the desired option in the following figure.

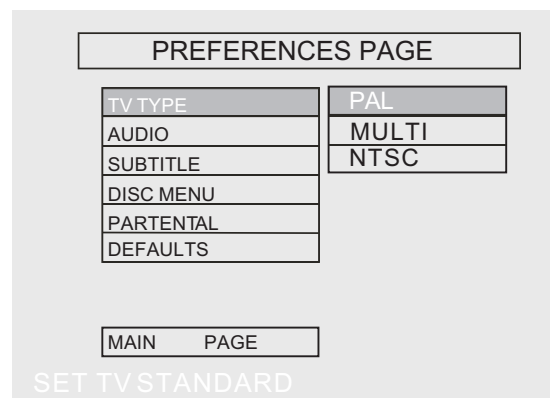

This product supports output of various system, including MULTI, NTSC, PAL.

1) If your TV set has only NTSC or PAL system, the screen will blink and become colorless when a wrong system is selected. In this case, press the N/P button on the R.C to return to normal screen. Always remember to select the correct system.

2) For more information of output format, refer to the instructions or your TV set.

### DUBBING LANGUAGE

Follow the operating instructions stated in "DVD MENU SETUP" in combination with the desired option in the following figure.

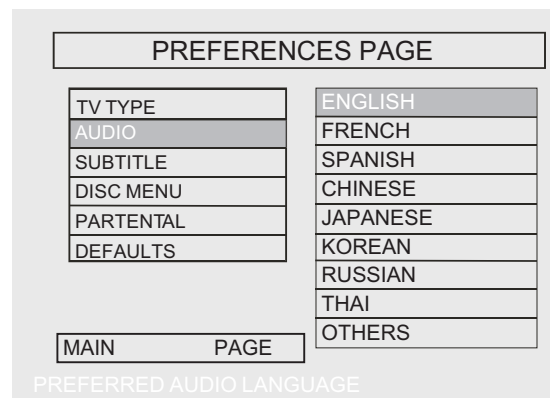

This machine provides English, French, Spanish, Chinese and Japanese Korean, Russian, Thailand as the built-in disc dubbing language options.

### SUBTITLE

This machine provides English, French, Spanish, Chinese and Japanese as the built-in subtitle languages. When a DVD is played, the user may hide the subtitle or choose any of them as the preset subtitle language.

Follow the operating instructions stated in "DVD MENU SETUP" in combination with the desired option in the following figure.

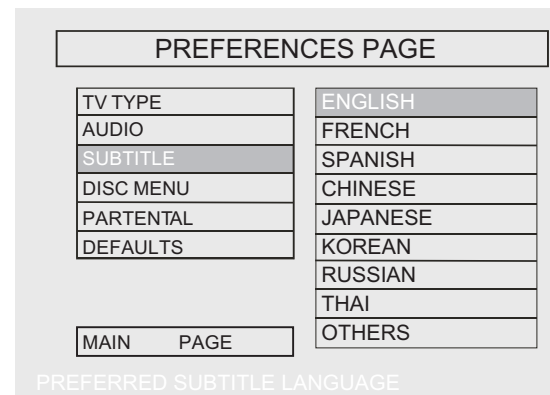

### DISC MENU LANGUAGE

This machine provides English, French, Spanish, Chinese, Japanese Korean, Russian, Thailand and OFF as the film's menu language options.

Follow the operating instructions stated in "DVD MENU SETUP" in combination with the desired option in the following figure.

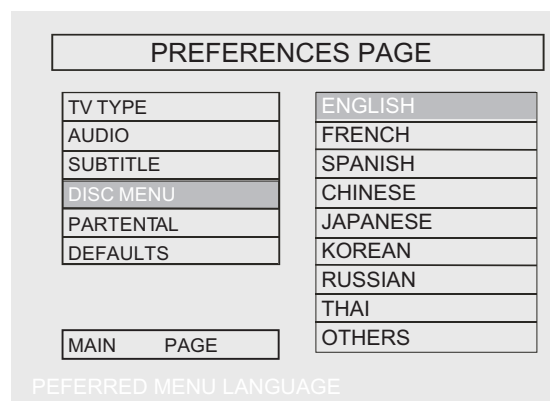

This page contains valuable information regarding the handling, cleaning, and storage of discs played in this unit.

### Handling

- Do not touch the playback side of the disc.
- Do not attach paper or tape to discs.
- Do not stick or write anything on the surface. Protect against fingerprints.
- Always hold a disc by the center and edge portions.

### Cleaning

- Fingerprints and dirt on the disc may cause picture and/or sound deterioration. Wipe the disc from the center outward with a soft cloth. Always keep the disc clean.
- If you cannot wipe the dirt off, lightly use a slightly moistened soft cloth and finish with a dry cloth.
- Do not use any type of solvent such as: Paint thinner, benzene, commercially available cleaners or anti-static spray for vinyl LPs.

### Storing

- Do not store discs in places subject to direct sunlight or near heat sources.
- Do not store discs in places subject to moisture and dust.
- Store discs vertically in a case. Stacking or placing objects on discs outside of their case may cause warping.

**NOTE:** CURTIS Technology is not responsible for damage that may occur to any disc that is operated in this unit or not handled, cleaned, or stored as suggested above.

## Front Panel Functions

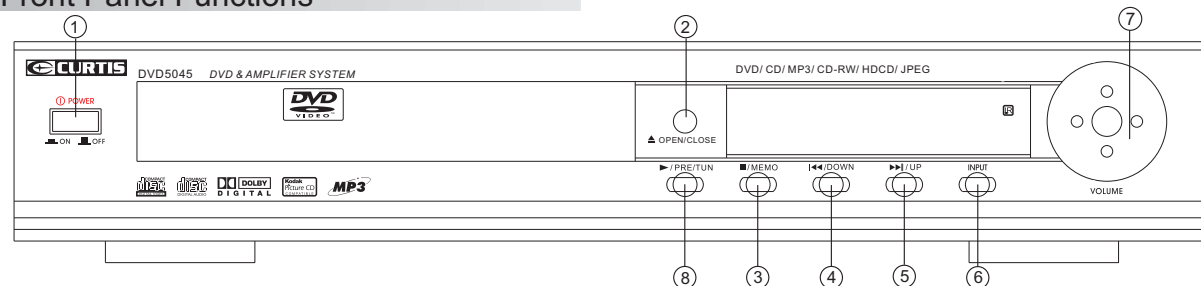

### 1. POWER

Before plugging the power cord into the AC outlet, check to make sure all of the connections have been properly completed. When they have been done, carefully plug power cord into outlet.

Press the POWER button on the front panel to power the unit.

When the unit is initially powered, a brief surge of electricity may cause interference with other electronic equipment on the same circuit. If this occurs, connect the unit to an outlet on a different circuit.

### 2. ▲/OPEN/CLOSE

Use this button to open and close the disc tray while in DVD mode. It is disabled when another signal source is used.

### 3. ■/MEMO

Use this button to stop play function while in DVD mode.

While in the tuner mode, this button is used to memory station.

### 4. I◀◀/DOWN

While in the DVD status, you may press this button for previous track.

While in the tuner mode, you may press this button for radio down search.

### 5. ▶▶/UP Button.

While in the DVD status, you may press this button for next track.

While in the tuner mode, you may press this button for radio up search.

### 6. INPUT SIGNAL SOURCE

Use this button to select the proper input signal source. (Note: The selected input will correspond to the selected input terminal on the rear panel.)

### 7. VOLUME

Use this button to control the unit's volume. It controls all six channels simultaneously.

### 8. ▶/PRE/TUN

When in the Tuner mode, this button is used to select presetting or tuning mode.

Use this button to begin play function while in DVD mode.

## Back Panel Functions

### 1. ANTENNA

Use to connect the provided indoor FM and AM loop antennas.

### 2. AUX IN

Use to connect input for both auxiliary 1 and 2 music sources.

### 3. AUDIO OUT

Use to connect both the right and left channel line outputs as well as subwoofer output.

### 4. VIDEO OUTPUT

### 5. OPTICAL OUTPUT

### 6. S-VIDEO OUTPUT

### 7. REAR

Use to connect the four terminals of the left and right surround sound speakers.

### 8. FRONT/MAIN

Use to connect the four terminals of the left and right front or main speakers.

### 9. CENTER/SUBWOOFER

Use to connect the four terminals of the center and subwoofer speakers.

### 10. COAXIAL OUTPUT

### 11. 120V/60Hz

This unit comes with an AC power cord. Be sure its prongs are dry before plugging it into an electrical outlet. Take caution not to overextend the cord or walk on it.

### 12. COMPONENT VIDEO OUTPUT

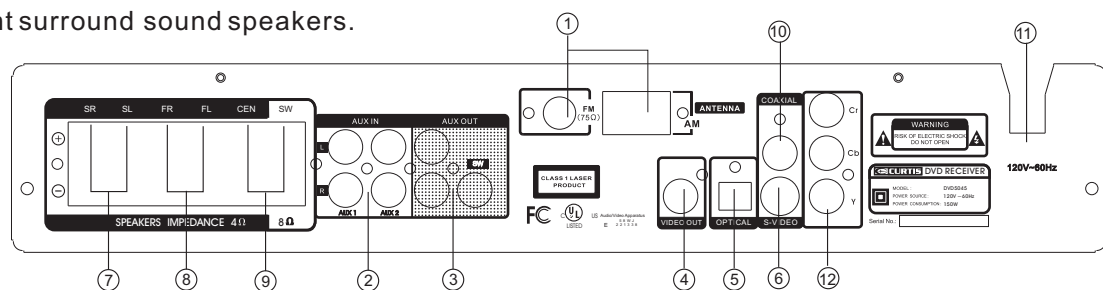

“DVD menu setup” in combination with desired option in the following figure.

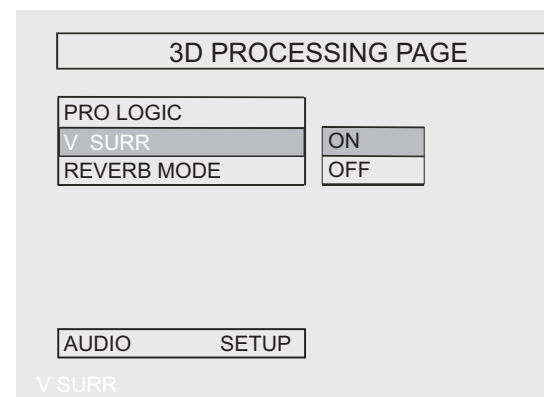

Virtual surround is set to ON or OFF.

### REVERB MODE

Follow the operation instructions stated in “DVD menu setup” in combination with desired option in the following figure.

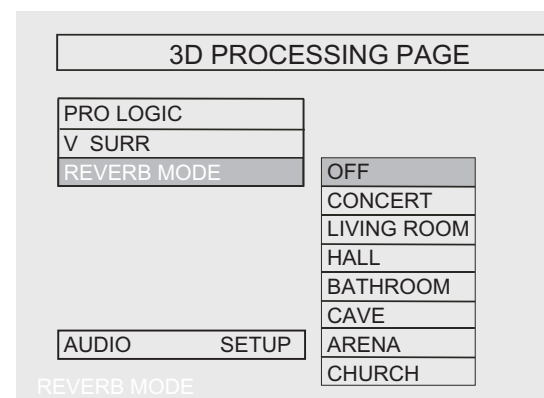

### VIDEO SETUP

Video setup includes: brightness, contrast and video output.

### BRIGHTNESS

Follow the operation instructions stated in “DVD menu setup” in combination with desired option in the following figure.

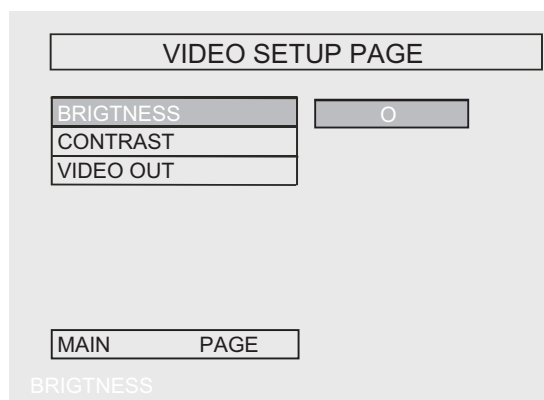

Press right arrow button to enter adjustment mode; press up and down buttons to make adjustment.

Press left arrow button to return to setup menu.

### CONTRAST

Follow the operation instructions stated in “DVD menu setup” in combination with desired option in the following figure.

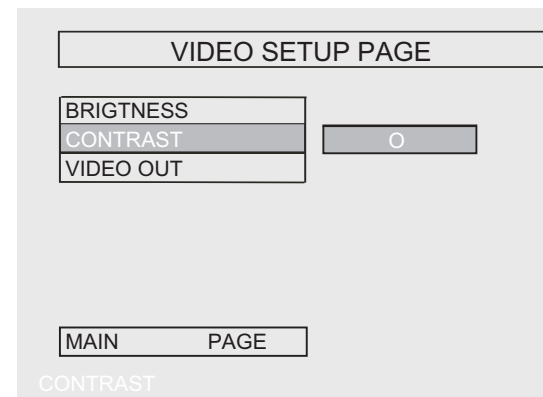

Press right arrow button to enter adjustment mode; press up and down buttons to make adjustment.

Press left arrow button to return to setup menu.

### VIDEO OUTPUT

Follow the operation instructions stated in DVD menu setup in combination with desired option in the following figure.

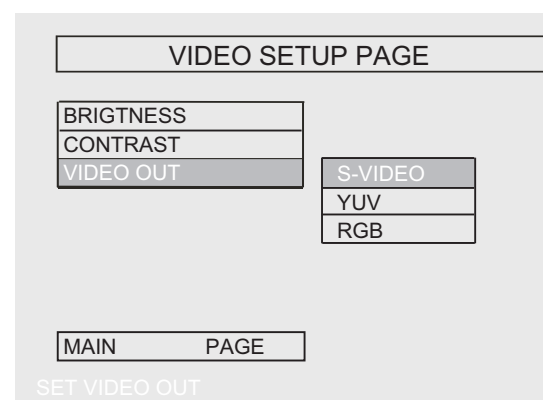

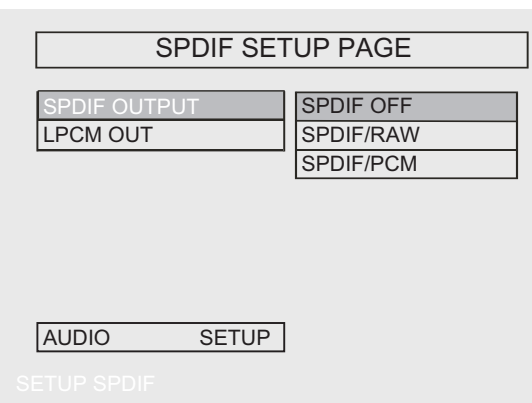

### LPCM OUTPUT

To avoid disturbing neighbours at night, use this function to low down the volume without changing the original tone.

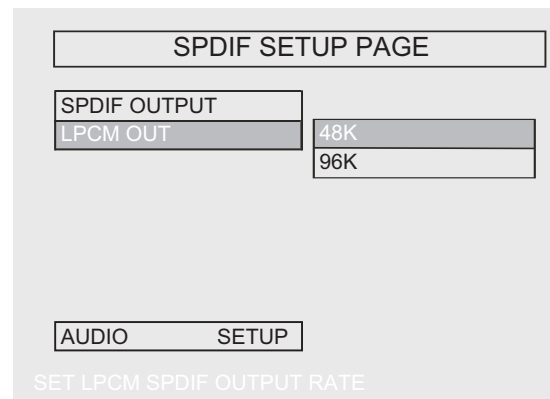

### DOLBY DIGITAL SETUP

Dolby digital setup includes dual mono and dynamic range compress.

#### STEREO SETUP

Follow the operation instructions stated in "DVD menu setup" in combination with desired option in the following figure.

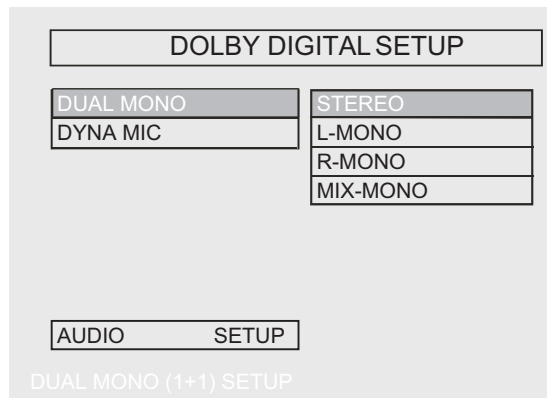

If you have Dolby digital input in your amplifier/decoder, you may select stereo. Left, right and mixed sound accordingly.

#### DYNAMIC RANGE COMPRESS

Follow the operation instructions stated in "DVD menu setup" in combination with desired option in the following figure.

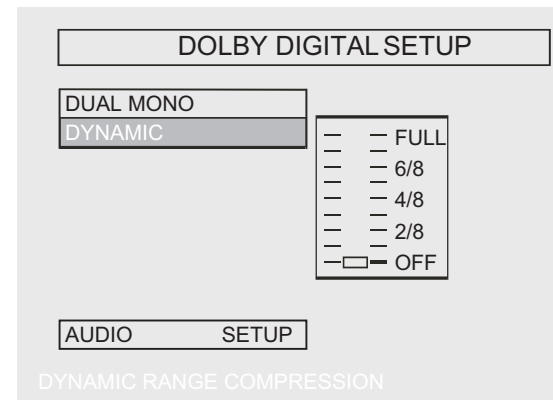

### CHANNEL DELAY SETUP

Includes adjust the listening distance of center, surround and subwoofer.

#### CHANNEL DELAY

Follow the operation instructions stated in "DVD menu setup" in combination with desired option in the following figure.

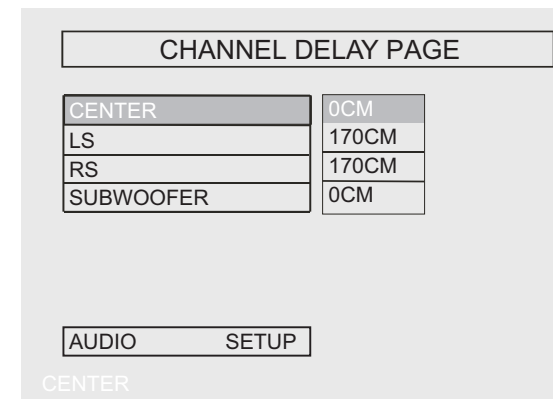

Note: the longest distance is 510 cm.

### 3D PROCESS SETUP

Includes PRO LOGIC, virtual surrounds, reverb mode.

#### PRO LOGIC SETUP

Follow the operation instructions stated in "DVD menu setup" in combination with desired option in the following figure.

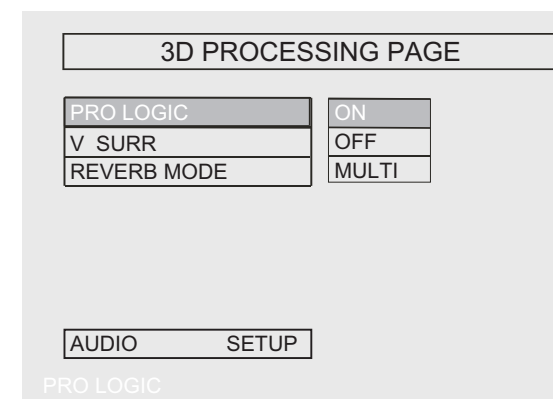

PRO LOGIC is set to ON, OFF or MULTI.

#### VIRTUAL MODE

Follow the operation instructions stated in

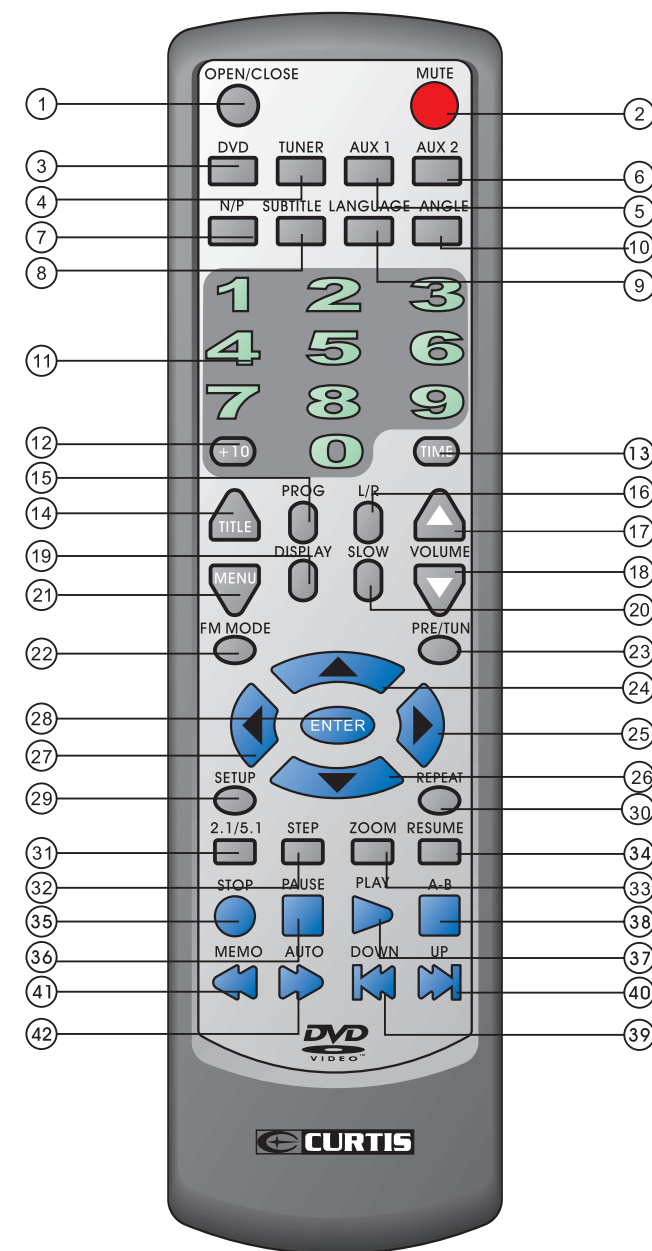

- ① OPEN/CLOSE
- ② MUTE
- ③ DVD SELECTOR
- ④ AM/FM TUNER
- ⑤ AUX1 SELECTOR
- ⑥ AUX2 SELECTOR
- ⑦ N/P SELECTOR
- ⑧ SUBTITLE
- ⑨ LANGUAGE
- ⑩ ANGLE
- ⑪ 0-9 NUMBER KEYS
- ⑫ +10
- ⑬ TIME
- ⑭ TITLE
- ⑮ PROG
- ⑯ L/R CHANNEL SELECTOR
- ⑰ VOLUME INCREASE
- ⑱ VOLUME DECREASE
- ⑲ SCREEN DISPLAY
- ⑳ SLOW MOTION
- ㉑ MENU
- ㉒ FM STEREO MODE
- ㉓ PRESET/TUNING
- ㉔ SCROLL UP
- ㉕ SCROLL RIGHT
- ㉖ SCROLL DOWN
- ㉗ SCROLL LEFT
- ㉘ ENTER
- ㉙ SETUP
- ㉚ REPEAT
- ㉛ 2.1/5.1DOWNMIXING SELECTOR
- ㉜ STEP
- ㉝ ZOOM
- ㉞ RESUME PLAY
- ㉟ STOP
- ㊱ PAUSE
- ㊲ PLAY
- ㊳ A-B REPEAT
- ㊴ DOWN (search down for radio stations/previous track)
- ㊵ UP (search up for radio stations/next track)
- ㊶ MEMO (memory/rewind skip)
- ㊷ AUTO (automatic search/forward skip)



## Battery Installation

1. Push down and out on the battery Compartment cover to remove it.
2. Insert the two "AAA" batteries into the battery compartment of the remote control, making sure the + and - signs on the batteries and inside the battery compartment match up.
3. Replace the battery compartment cover.

### Notes:

- Do not mix batteries from different manufacturers, nor old ones with new.
- If the remote control will not be used for an extended period of time, remove the batteries to prevent damage-causing corrosion.
- Remove dead batteries immediately to prevent damage-causing corrosion.
- If battery leakage occurs, wipe the battery liquid from the battery compartment, then replace both batteries.
- Always replace both batteries at the same time, using new, fully charged batteries.
- Life expectancy of batteries may vary depending on amount of use.

## Using the Remote Control

Point the remote control at the remote sensor on the DVD receiver. When the signal is received from the remote, the unit will function accordingly. The remote will operate to approximately 16' from the remote sensor at an angle of around 30° each direction.

### Notes:

- Do not direct the remote sensor toward any light source, such as direct sunlight or a strong fluorescent light, as it may cause the unit to not operate correctly.
- When other remote controls are used nearby or when the remote is used near equipment using infrared rays, interference may occur.
- Placing an object on the remote control may cause it to inadvertently depress a button, changing a function and shortening battery life.
- Do not glaze the front of the DVD receiver with colored glass, as it may cause interference with normal operation of the controller.
- Make sure there is no barrier between the remote control and remote sensor, as it could prevent the unit from receiving the signal.
- Do not spill water or put wet items on the remote control.
- Never disassemble remote control.



### BATTERIES

INCORRECT USE OF BATTERIES MAY CAUSE THEM TO LEAK, CORRODE OR EXPLODE.

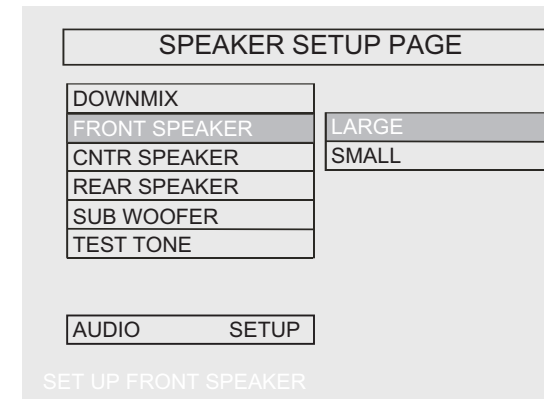

Front speaker is set to LARGE or SMALL.

### CENTER SPEAKER

Follow the operating instructions stated in "DVD MENU SETUP" in combination with the desired option in the following figure.

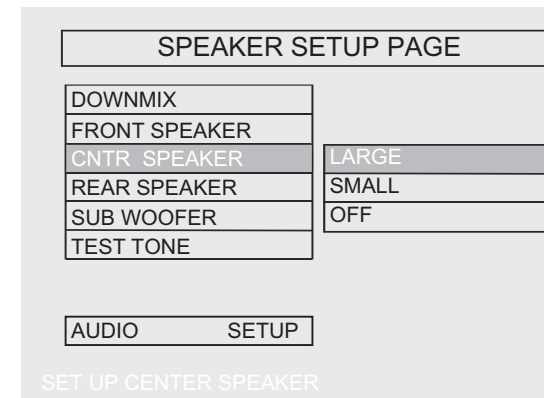

The center speaker is set to LARGE, SMALL or OFF.

### REAR SPEAKER

The rear speaker is set to LARGE, SMALL or OFF. Follow the operating instructions stated in "DVD MENU SETUP" in combination with the desired option in the following figure.

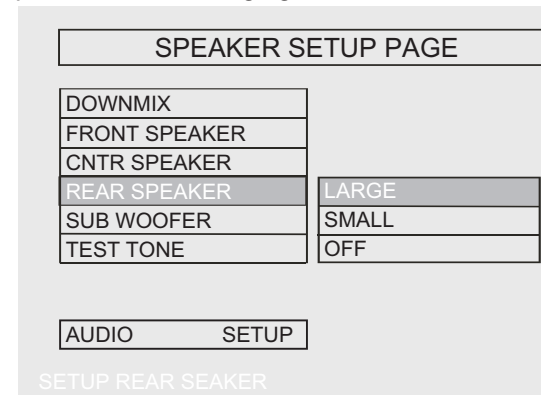

### WOOFER SPEAKER

The woofer speaker is set to ON or OFF. Follow the operating instructions stated in "DVD MENU SETUP" in combination with the desired option in the following figure.

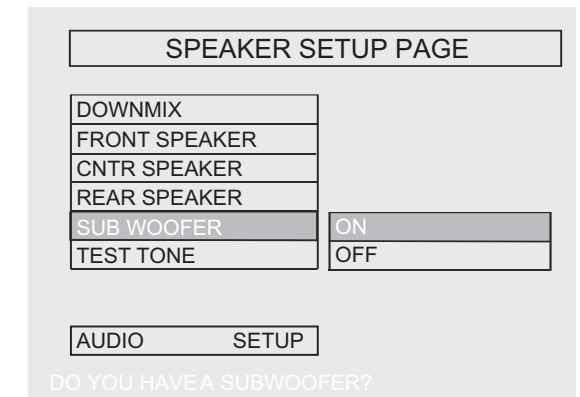

### TEST TONE

Follow the operation instructions stated in "DVD menu setup" in combination with desired option in the following figure.

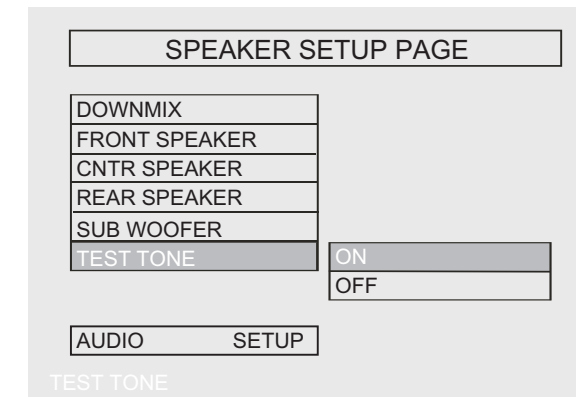

TEST TONE is set to "ON" or "OFF". This function can test LEFT, CENTER, RIGHT, RIGHT SURROUND, LEFT SURROUND in sequence.

### DIGITAL AUDIO SETUP

Includes digital audio output and LPCM output.

### DIGIAL AUDIO OUTPUT

Dolby digital or DTS signals can be output through COAXIAL in rear panel. Follow the operation instructions stated in "DVD menu setup" in combination with Desired option in the following figure.

## OSD LANGUAGE

The user may use this item to set the language of the setup menu and screen display to ENGLISH, CHINESE, FRENCH, GERMAN or SPANISH.

Follow the operating instructions stated in "DVD MENU SETUP" in combination with the desired option in the following figure.

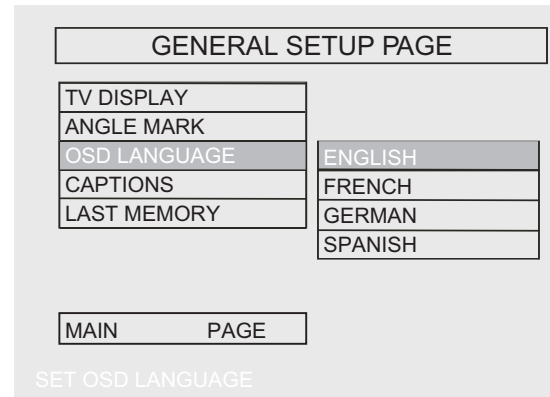

## HIDE SUBTITLE

Follow the operating instructions stated in "DVD MENU SETUP" in combination with the desired option in the following figure.

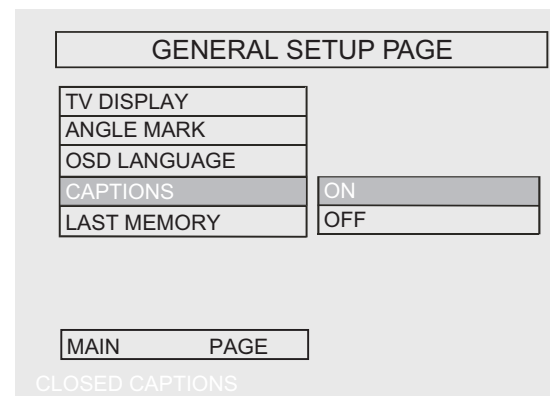

**Note:** This function doesn't work if the DVD doesn't show it.

## Memory Play Setting

According to following figure to get Selected Setting.

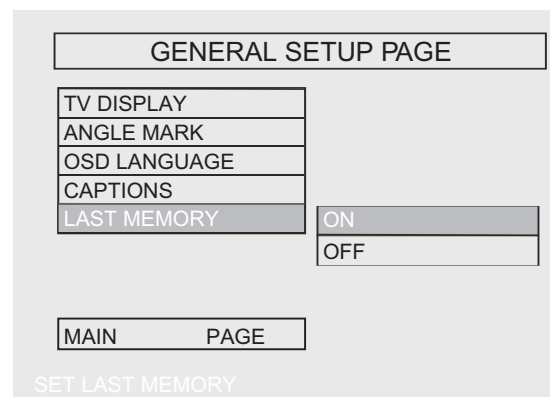

## AUDIO SETUP

Includesspeaker setup, digital Audio set up. Dolby digital setup, delay setup and 3 D process

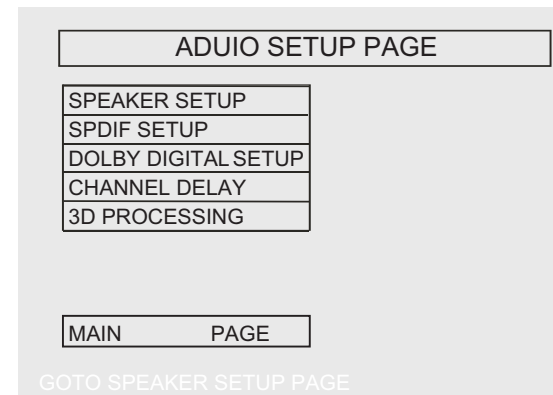

## SPEAKER SETUP

This submenu options include DOWNMIX MODE, FRONT, CENTER, REAR, SUBWOOFER, TEST TONE.

## DOWNMIX MODE

Follow the operating instructions stated in "DVD MENU SETUP" in combination with the desired option in the following figure.

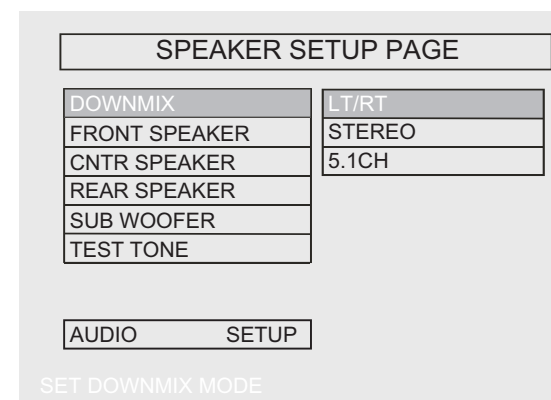

This setting is suitable for films. If you only need two channels to enjoy music, it's recommended to select the 2<sup>nd</sup> option. Where 5.1 theater sound is available, the 3<sup>rd</sup> option is recommended.

## FRONT SPEAKER

When set center, rear and subwoofer to "off" and front to "LARGE", then front audio signal can be mixed from center, rear and sub woofer speakers, Usually it is set to "SMALL".

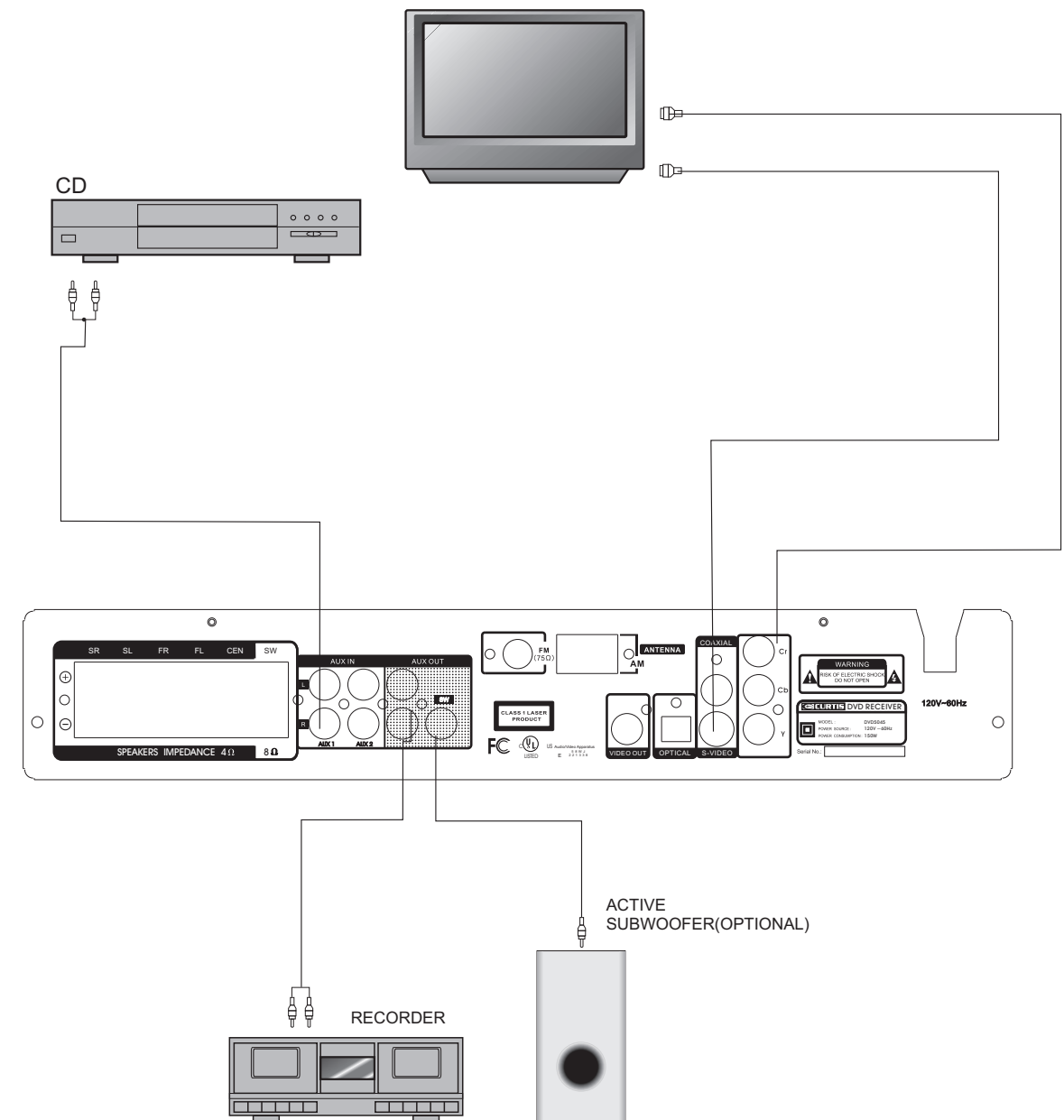

- Connection terminals for this DVD receiver are found on the rear panel. Read carefully and follow the manufacturers' instructions of any video and audio device being connected to this unit.
- Do not connect the power until all connections have been properly completed.
- Red terminal (marked R) is for connecting the right channel. The white terminal (marked L) is for connecting the left channel. The yellow terminal is for video connection. Make sure all connections are securely made. Improper connections may cause noise, poor performance, or cause damage to the equipment.
- Do not tie the AV cord with any other cords, such as the power cord or speaker wires, as it may result in poor picture and/or sound quality.

## SPEAKERS

The configuration and arrangement of a surround sound system's speakers is critical. For maximum listening enjoyment, refer to the Arrangement of Speakers section in this manual prior to connecting speakers.

### Surround Sound Speakers

#### Front or main right and left speakers; center speaker

- These three speakers provide extensive sound imaging and augment the dynamic effect of the audio. A movie's principal dialogue comes through these speakers.

#### Rear or surround sound speakers

- These two speakers provide 3-D dynamic sound effects, and create an enveloping atmosphere, as they add background sounds.

#### Subwoofer speaker

- Provides rich and powerful bass, adding a powerful dimension of realism.

**Note:** Audio recorded for the center speaker and subwoofer will be assigned to the front and 3-D rear speakers to obtain the optimum 3-D surround sound effect.

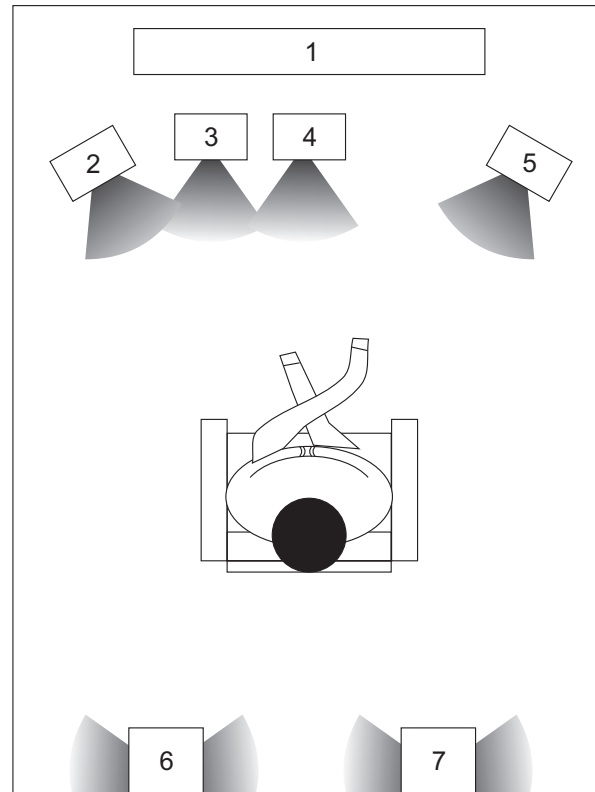

1. TV set or screen
2. Front or main left speaker
3. Subwoofer
4. Center speaker
5. Front or main right speaker

## ARRANGEMENT OF SPEAKERS

The ideal surround sound speaker configuration may vary according to room size and wall material. The figure below illustrates a typical arrangement.

### Hints:

- Front or main speakers and central speaker should be placed at the same level and in a way that sound is oriented toward the listener's ears.
- 3D surround sound or rear speakers should be placed 3' higher than the height of listener's ears.
- Subwoofer speaker may be placed anywhere within the room, as its location produces little effect on a listener's sensation to sound. To obtain the optimum bass effect, a subwoofer is recommended in home theater systems.

## FUNCTIONS

The repeat mode changes each time the REPEAT key is pressed (i.e., from title repeat to chapter repeat, all repeat, to repeat off.)

### Zoom

A picture may be enlarged up to four times during either playback or slow motion through the unit's zoom function. Press the ZOOM key once and it enlarges the image 2x; press a second time and the image enlarges 3x; A third pressing enlarges the image 4x. A fourth pressing enlarges the image 1/2x, a fifth pressing the image 1/3x, a sixth pressing the image 1/4x. To return to normal-size playback, press the ZOOM key a seventh time. Enlargement takes place in the center of the picture.

### L/R

When a DVD disc is played, the active language will be displayed. When a CD disc is played, the left or right track, or stereo will be displayed accordingly.

### Volume and Mute

The volume on this DVD receiver is easily controlled with the remote control by pressing either the VOL + key to raise the volume or the VOL- key to lower it. By pressing the MUTE key, no audio will be heard. To reinstate the audio, press the MUTE key again.

### Program

Allows you to program specific tracks in a desired order of play. To exit the Programmed play mode, press the program button again.

### DVD Menu Setup

By pressing the SETUP key on the remote control, the main setup menu appears. You will be asked to enter the Personal Identification Number (PIN), which is "0000". From the setup menu, you may choose the following options: general setup, speaker setup, audio setup, and preferences setup.

1. After accessing the setup menu, press the scroll key for up or down movement to select a desired item. Once an item is selected, press the ENTER key to confirm your entry and to move to the sub-entry.
2. Use the left or right scroll key to move the pointer and the up or down scroll key to select the desired option. Once an item is selected, press the ENTER key to confirm your selection. This completes the setup of the selected function.
3. To end the setup, press the SETUP button again.

## SYSTEM SETUP

### GENERAL SETUP

This option is used to set up the TV-screen format, and DVD functions with options of TV display, last memory, angle mark, OSD lang., and captions.

### TV form

Follow the operating instructions stated in "DVD MENU SETUP" in combination with the desired option in the following figure.

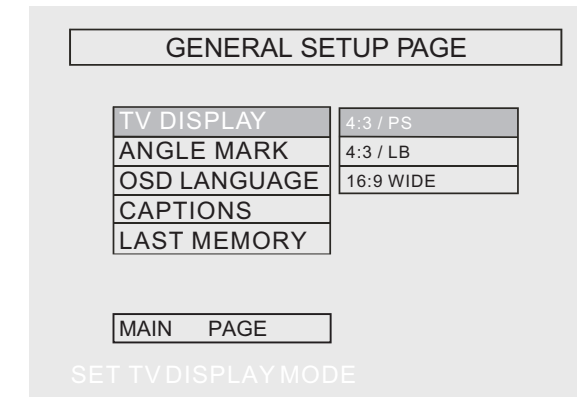

### Note:

- 1). Irrespective of what screen format you have selected, if your screen displays in 4:3 format, the picture will be shown in that format anyway.
- 2). For DVDs, the screen format is convertible.
- 3). If your screen displays in 4:3 format, when a DVD with 16:9 display format is used, the picture will be flattened.

TV screen / Film format	4:3			16:9
	Normal	Full view	Mailbox	Wide screen
4:3				
16:9				

### Angle MARK

When a DVD providing multiple angles is used, the user may select a particular shooting angle. Follow the operating instructions stated in "DVD MENU SETUP" in combination with the desired option in the following figure.

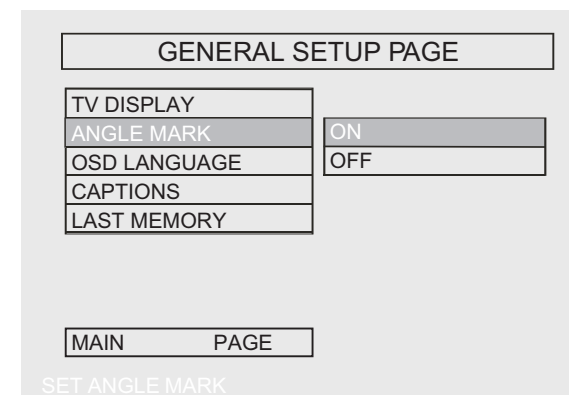

## Time

This DVD receiver can display various data regarding the disc being played. Press the TIME button for the following.

1. Press once, the number of titles and chapters in each title appears

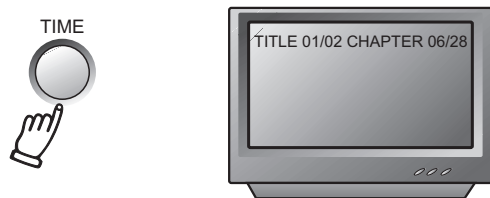

2. Press again, the time of a selected title appears.



Pressing the TIME button while playing a CD disc allows you to enter, using the number keys, the amount of time you want the disc to play. For example, 55:50, stands for 55 minutes and 50 seconds.



## MENU: MENU/PBC

With the PBC function on, choosing a song on a CD can only be done when at the main menu. With the PBC function off, song selections can be made by entering the relevant number keys. The menu content of the disc will appear when the MENU button is pressed while a DVD disc is playing.



## A-B Repeat

The A-B repeat function allows you to reshuffle sections between two specific points (A and B) on a disc.

1. Press the A-B button while the disc is playing to set point A, the beginning spot.

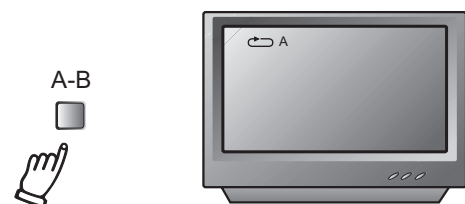

2. Press the A-B button again while the disc is playing to set point B, the ending spot. The section between A and B will replay.



3. Press the A-B button a third time to cancel.



## Repeat Play

This DVD receiver allows repeated playback of specific titles, chapters/tracks, or segment. It even allows switching between two items that are being repeated.

1. Select the item to repeat.  
2. Press the REPEAT key.

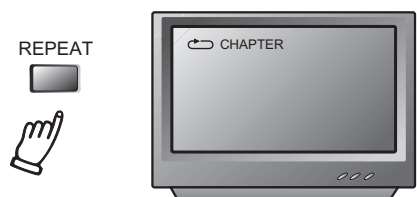

This well-designed DVD receiver provides optimum sound quality when the speakers used are within the range of their rated impedance.

## Important

- The minimum impedance of the five speaker terminals is 4 ohm; for the subwoofer, it is 8 ohm.
- If you want to use only one speaker or listen to monophonic music, do not parallel connect individual speakers to the left and right channel terminals. See the figure on the left below.

## Connecting Speaker Cables

- Peel off approximately 1/2" of cable insulation
- Tighten the wire end (#2 below)
- Open cable terminal by pressing back On tab
- Insert wire end into terminal
- Release tab; make sure wire is in terminal securely

**Note:** To prevent damage to the circuit, care should be taken to prevent short circuiting from occurring at the positive and negative poles of the speaker cord.

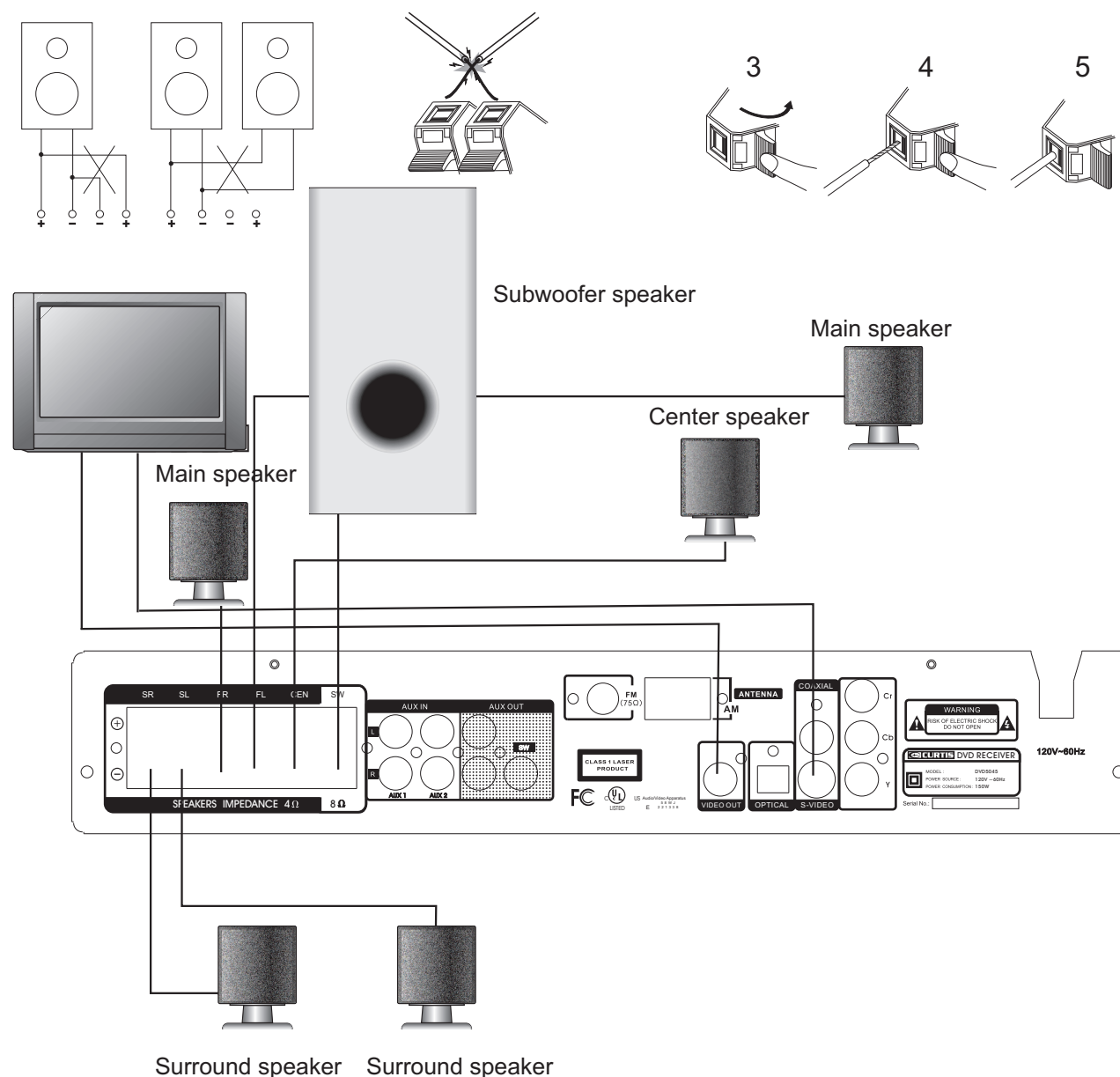
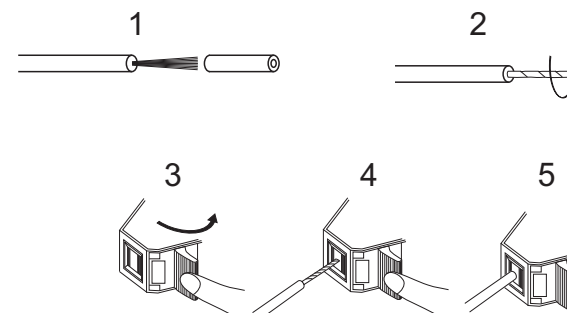

## CONNECTING ANTENNA

Radio signals may be difficult to receive in some buildings and under certain conditions. The provided antennas will help in their reception. They are intended for indoor use only.

### AM Loop Antenna

The placement of the AM loop antenna should be in a direction that provides the clearest reception. Keep as far as possible from DVD receiver, TV set, and speaker and power cords. If reception remains poor, an outdoor antenna may be necessary.

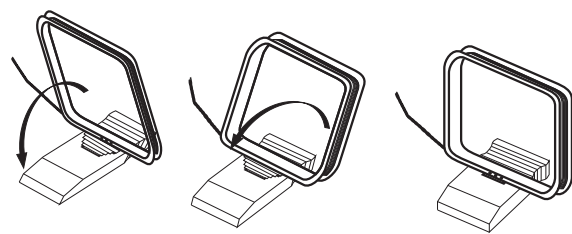

### To connect the AM loop antenna:

1. Hold down handle
  2. Insert wire end into hole
  3. Release handle
- Position for best reception

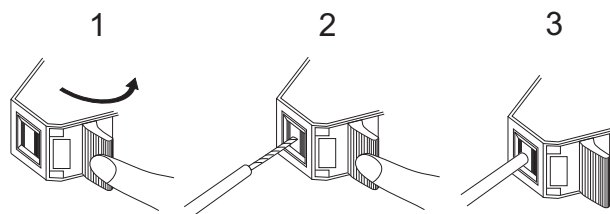

### FM Indoor Antenna

The FM antenna should be fully extended and in a direction that provides the clearest signal. Secure the antenna ends in a location where distortion is a minimum. If reception remains poor, an outdoor antenna may be necessary.

### To connect the FM antenna:

1. Open cable terminal by pressing back on tab
2. Insert wire end
3. Release tab; make sure wire is in terminal securely

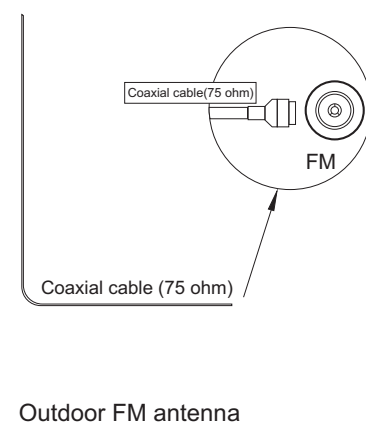
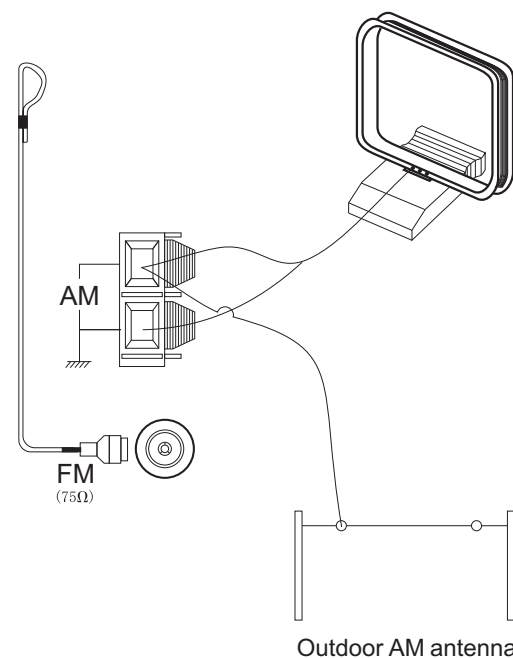

## FUNCTIONS

### N/P

This DVD receiver supports video output of various systems, including auto, NTSC, and PAL. The picture will blink and become colorless when the wrong system is selected. If this occurs, press the N/P key on the remote control, then select the correct system (NTSC for North America, PAL for Europe). For more information on output format, refer to the TV set's manufacturer's instructions.

### Subtitles

The unit has the capability to display subtitles in any of 32 different languages.

1. Press the SUBTITLE key. The subtitle menu will appear. Scroll to the desired language, then press the SUBTITLE key again.

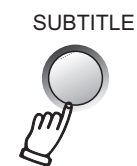

2. To remove the subtitles from view, press the SUBTITLE key until they disappear.

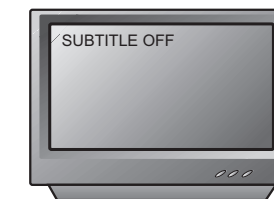

Note: The disc being played must be multi-subtitle encoded.

### Camera Angle

The ability to change the camera angle allows viewer to play director and watch a movie from different perspectives.

1. Press the ANGLE key on the remote control. With each press, the camera angle changes.
2. The key may be pressed only when the flashing angle icon appears in the unit's display panel.



Note: Camera angle may be changed only in discs with multi-angle capability encoded into them.

### Language

The unit has the capability to show movies in one of eight languages.

1. Press the LANGUAGE key. The language menu will appear. Scroll to the desired language, then press the LANGUAGE key again.



Note: The disc being played must be multi-language encoded.

### LOCATING A TITLE

DVD discs are normally divided into titles, which are then sub-divided into chapters. A specific title can be easily found with this unit. Specific titles can be found using either the title menu function, if the DVD disc contains a title menu, or through its unique title number.

### Title Menu Function

1. Press the TITLE key. The title menu will appear on the TV screen.
2. Press the appropriate scroll key to select the desired title. A title may also be located by pressing its assigned number with the number buttons.
3. Press the TITLE key again. This will start playback from chapter 1 of the selected title.

### Note:

Some discs do not respond to this function. If different instructions appear on the TV screen, follow those instructions. The Instructions given here describe the basic procedure. Procedures may vary depending on the content of the DVD disc. (When playing a VCD 2.0 disc, TITLE key can be used to return to menu.)

### Title Number

1. Press the appropriate numbers in the number section of the remote control. For example, for title 15, press the 10 and the 5 keys; for title 25, press the 10, 10, 5 keys.

## BASIC DVD OPERATION

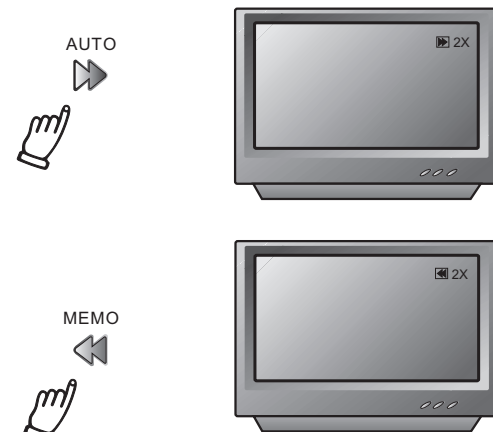

To activate either function, simply press the **▶▶** key or **◀◀** key on the remote control. The speed changes each time the key is pressed. To resume normal playback, press the **▶** key.

### Memory Playback

This unit allows the viewer to stop playback, then later continue playback from that exact disc location. Press the **STOP** key to halt playback. The unit then will memorize the location where playback was stopped. To resume watching, press the **RESUME** or **▶** key and the unit will resume playback from the exact location where playback was stopped. (Exclude Mp3 DISC)

When you play DVD discs, press **MENU** or **TITLE** key return menu and title, the unit then will memorize the location, To resume watching press the **RESUME** key and the unit will resume playback from the exact location.

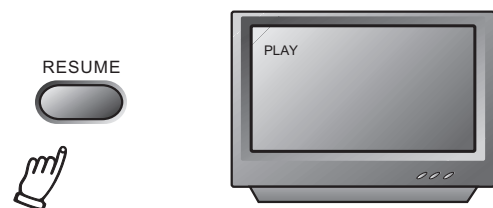

### Slow Motion

This DVD receiver has the ability to play discs in slow motion in either forward or reverse direction. Each time the **SLOW** key is pressed, the speed will slow from forward slow speed 1/2, to 1/4, to 1/8, to 1/16 to reverse slow speed 1/2, to 1/4, to 1/8, to 1/16, to normal speed. To resume normal playback, press the **▶** key.

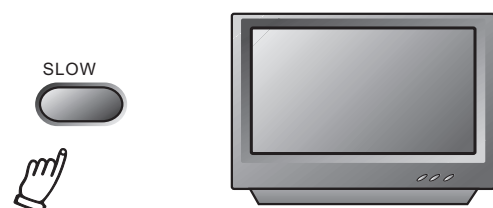

## FUNCTIONS

### Screen Display

While a disc is playing, the status of various functions may be checked, such as the title, track number, and several time categories.

1. Press the **DISPLAY** key once and the title appears along with the chapter and how much time has played.

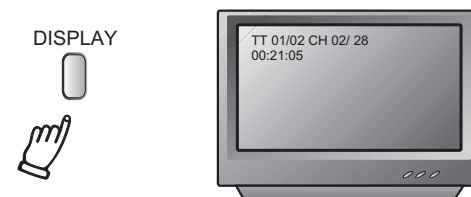

2. Press the **DISPLAY** key again and the remaining time for that particular title appears.

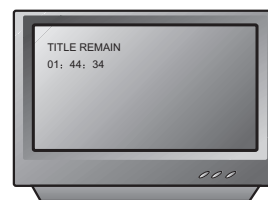

3. Press the **DISPLAY** key again and the total elapsed time for that particular chapter appears.

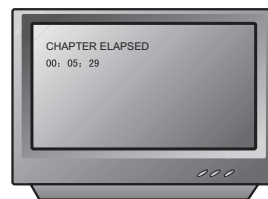

4. Press the **DISPLAY** key again and the total remaining time for that particular chapter appears.

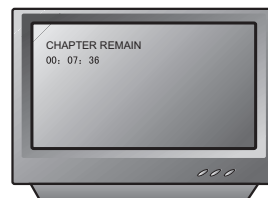

5. Press the **DISPLAY** key again and the display turns off.

## CONNECTING POWER SUPPLY

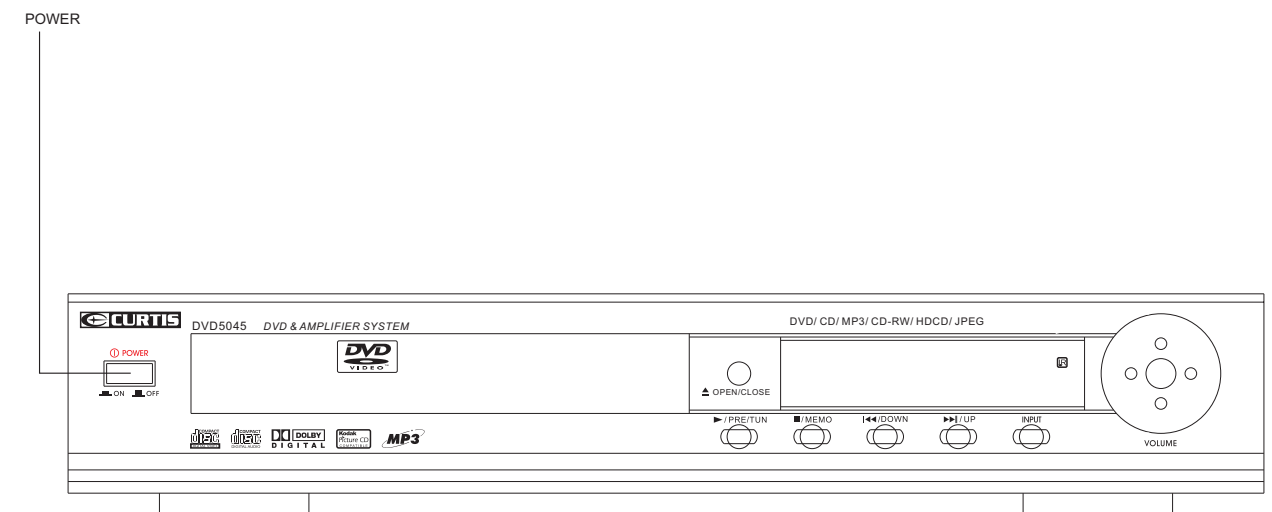

Before plugging the power cord into the AC outlet, check to make sure all of the connections have been properly completed. When they have been done, carefully plug power cord into outlet.

Press the **POWER** button on the front panel to power the unit. The display panel will light.

When the unit is initially powered, a brief surge of electricity may cause interference with other electronic equipment on the same circuit. If this occurs, connect the unit to an outlet on a different circuit.

## BASIC OPERATION

### Selecting Sound Source

1. Press any function button (DVD, AM/FM, AUX1, AUX2) to select the desired sound source. The appropriate symbol will appear in the display.
2. When the AM/FM tuner button is pressed, the last station listened to will play.

**Note:** The desired program source will not play unless it and the selected signal button coincide with the active program source signal input.

### Volume Control

The volume may be adjusted by either turning the large volume knob on the front panel or using the appropriate volume button on the remote control. Range from 0 to 80 levels.

### Mute

Pressing the **MUTE** button temporarily mutes every speaker. To resume audio, press **MUTE** button again.

## PLAYING THE RADIO

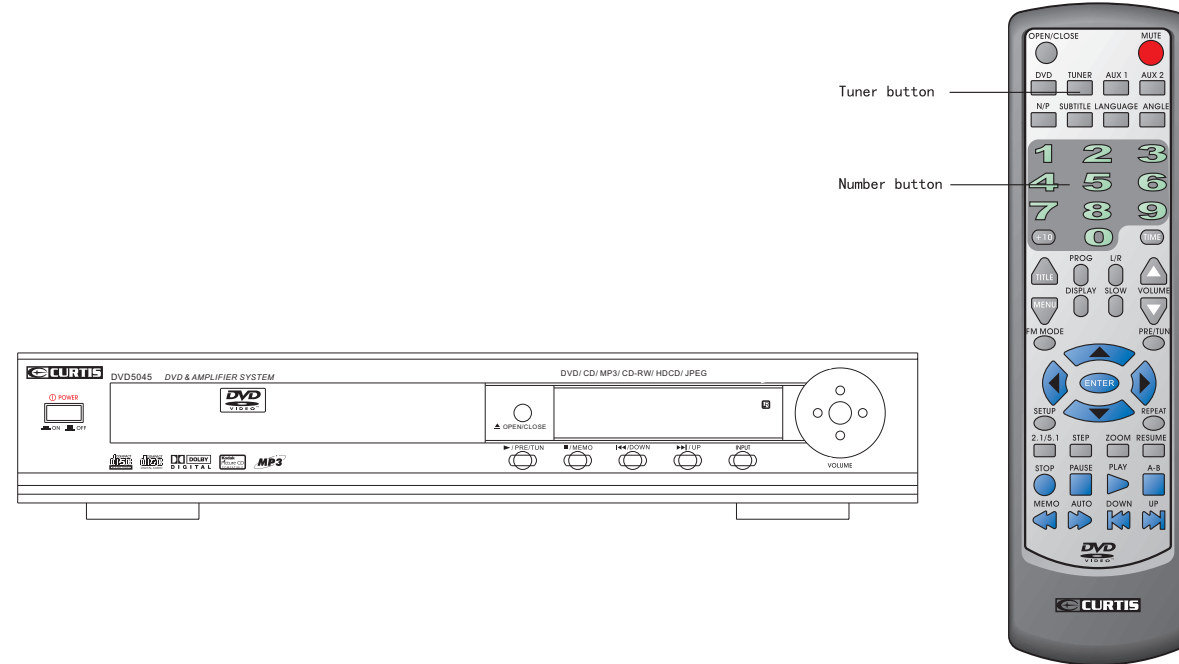

### Positioning

1. Press TUNER button to select desired wave band (AM or FM).
2. Press UP or DOWN button to find a station. The frequency will change with each press. When a station's signal is received, it will appear in the display.
3. To lock onto a station quickly, hold the UP or DOWN button for two seconds. The unit will start automatic tuning. When a station is found, automatic tuning stops.
4. To add a station to memory, press the MEMO button. The memory storage number will blink for four seconds in the display. Press MEMO again to store the station.

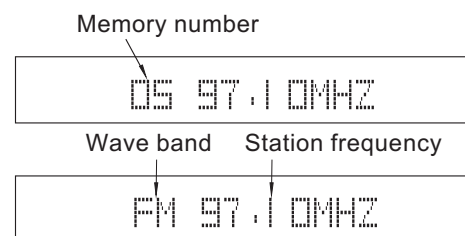

5. To reduce noise when an FM-stereo program has been received, press the FM MODE button. The word STEREO will disappear from the display. The program is now heard in monographic form, reducing the noise. To resume stereo play, press the FM MODE button again.

### Automatic Tuning

This unit will store up to should be total 50 individual (AM and FM) radio stations in its memory.

1. Press the AUTO button. The word AUTO will appear in the display and the automatic tuning mode is activated.
2. Stations will be stored in ascending order until 50 stations of that particular wave band have been saved. When a station is stored, the memory storage number, as well as the station's frequency, will flash for four seconds in the display.
3. When the total number of stations reaches 50, no further station in that wave band will be saved.

### To Play Preset Stations

1. Press the TUNER button to select the desired wave band.
2. Press the PRE/TUN button.
3. Press any of the numbered buttons to select the desired station's memory number. For example, to play the station at memory #5, simply press the 5 button; for memory #17, press the 1 button followed by the 7 button.
4. Stations in the memory function may also be accessed by pressing the UP or DOWN button.

## BASIC DVD OPERATION

Once the unit is connected to a television set and any other accessory equipment, you are ready to enjoy the excitement of DVD videos or your favorite CDs and MP3 files.

### To play a DVD video disc:

Turn on the TV and select the A/V mode. If the set features an S-Video connection, be sure the S-Video mode is selected from the TV menu. Turn on amplifier, if connected. Select AC-3 or DVD mode.

### To play an audio disc:

Turn on the audio system and choose the input source that is connected to the DVD player. Set the AUDIO OUTPUT to DIGITAL OUTPUT OFF from the SETUP MENU display if you don't have the proper equipment for Dolby Digital surround sound.

1. Press the POWER key on front panel. DISC LOADING appears on screen.

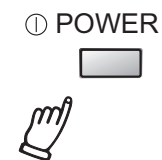

If there is no disc, NO DISC shown on screen:



2. Press the OPEN/CLOSE key. The disc tray will open.

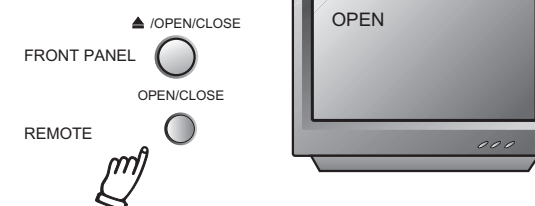

3. Place the disc on the disc tray. Be sure play side is face down on the tray.

4. Press OPEN/CLOSE key to close tray. The disc tray will close. The disc type will appear in the upper-left-hand corner of the screen.

Once it has read the disc, the unit automatically will begin playback. When playing a DVD, the DVD title or menu will appear. CD tracks are played in sequence.

### Note:

- It is possible to damage a disc if it is not placed correctly on the guides in the disc tray. This may also cause the DVD player to malfunction. Do not force or place anything other than a 5" DVD or CD onto the disc tray.
- Never move the DVD player during playback, as this may cause damage to the disc as well as the player. To open and close the disc tray, only use the OPEN/CLOSE key found on both the remote control and on the unit's front panel.

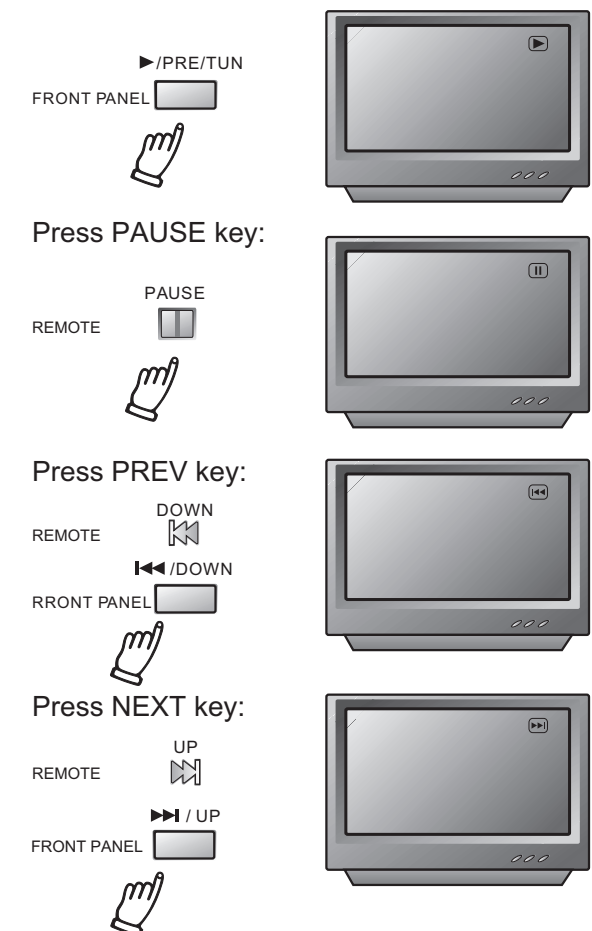

### Fast Forward/Reverse Playback

The unit features both fast forward and fast reverse playback. Either mode will speed up: 2x, 4x, 8x, 16x.